

# **Architecture of 8085 microprocessor**

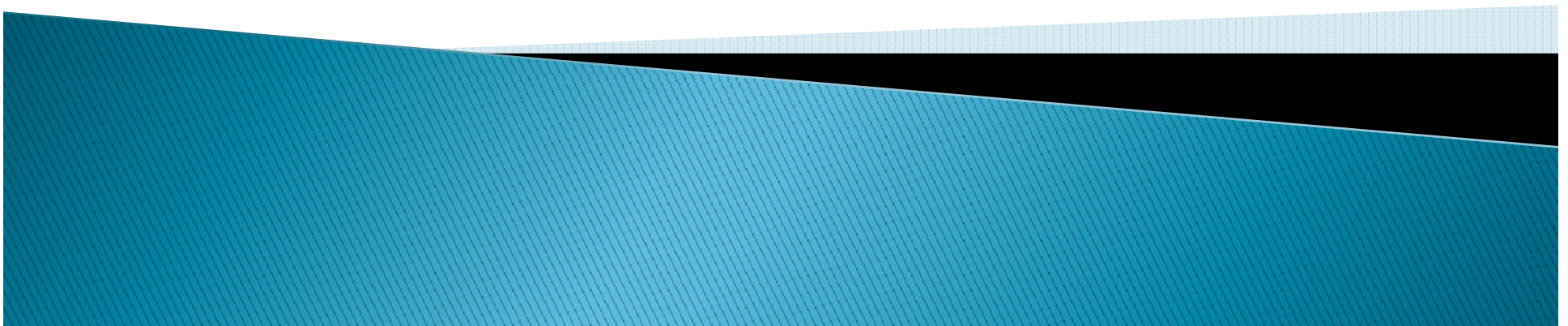

# Introduction

- ▶ A microprocessor is a multipurpose, programmable logic device that reads binary instructions from a storage device called memory accepts binary data as input and processes data according to those instructions and provides result as output.

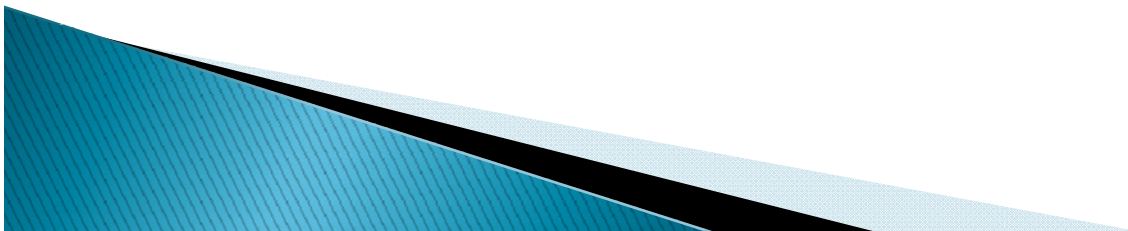

# Applications of microprocessor

- ▶ It is used in many microprocessor based electronic devices
  - i. For measurements, display and control of current, voltage, temperature, pressure, etc.
  - ii. For traffic control and industrial tool control.
  - iii. For speed control of machines.

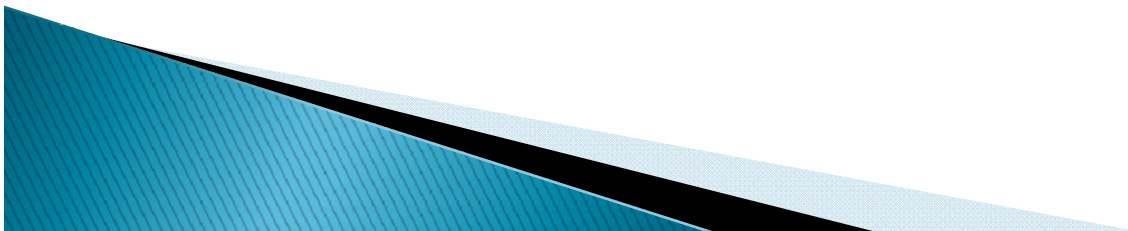

# Pin diagram of 8085

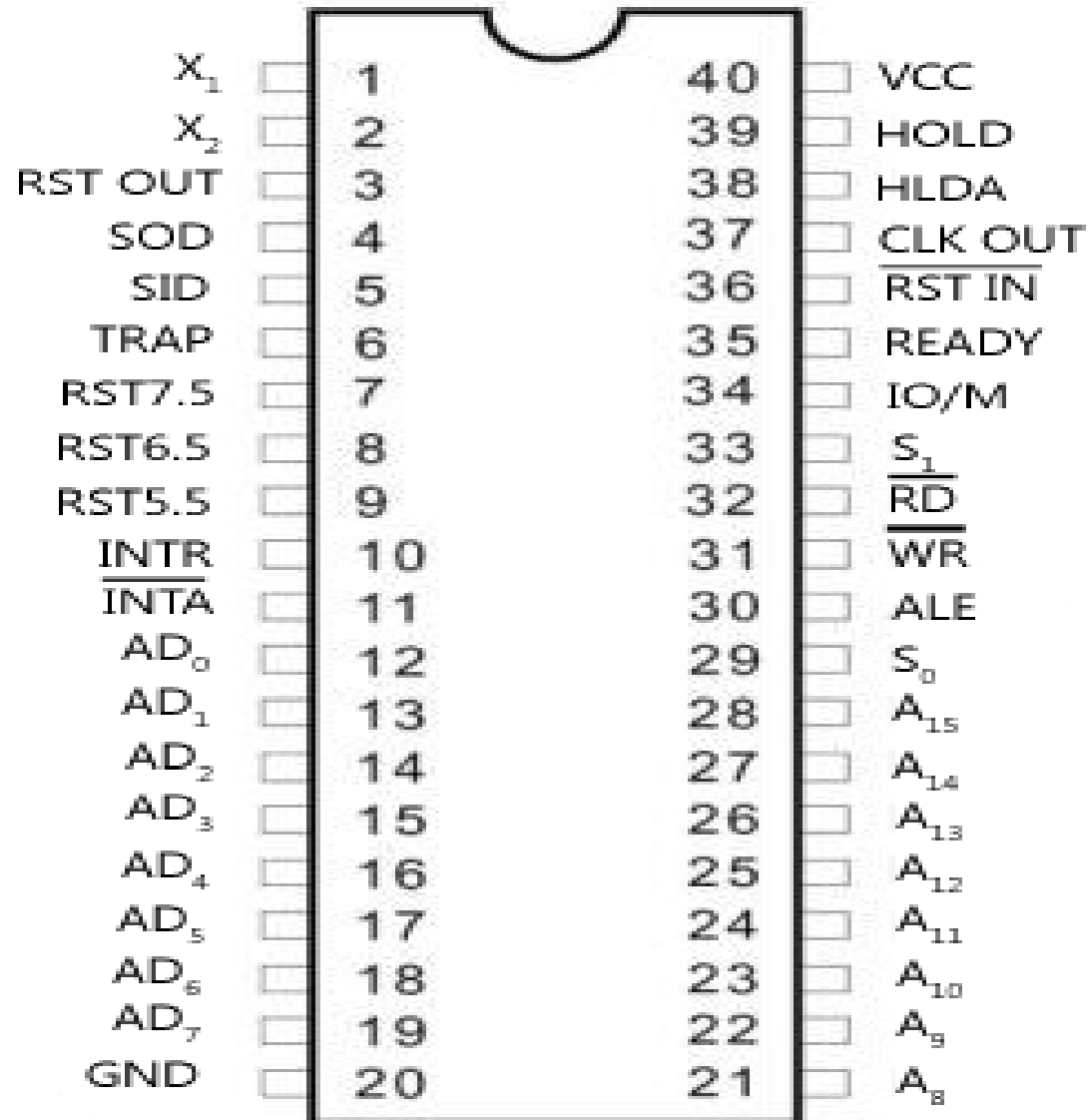

# 8085 Microprocessor Architecture

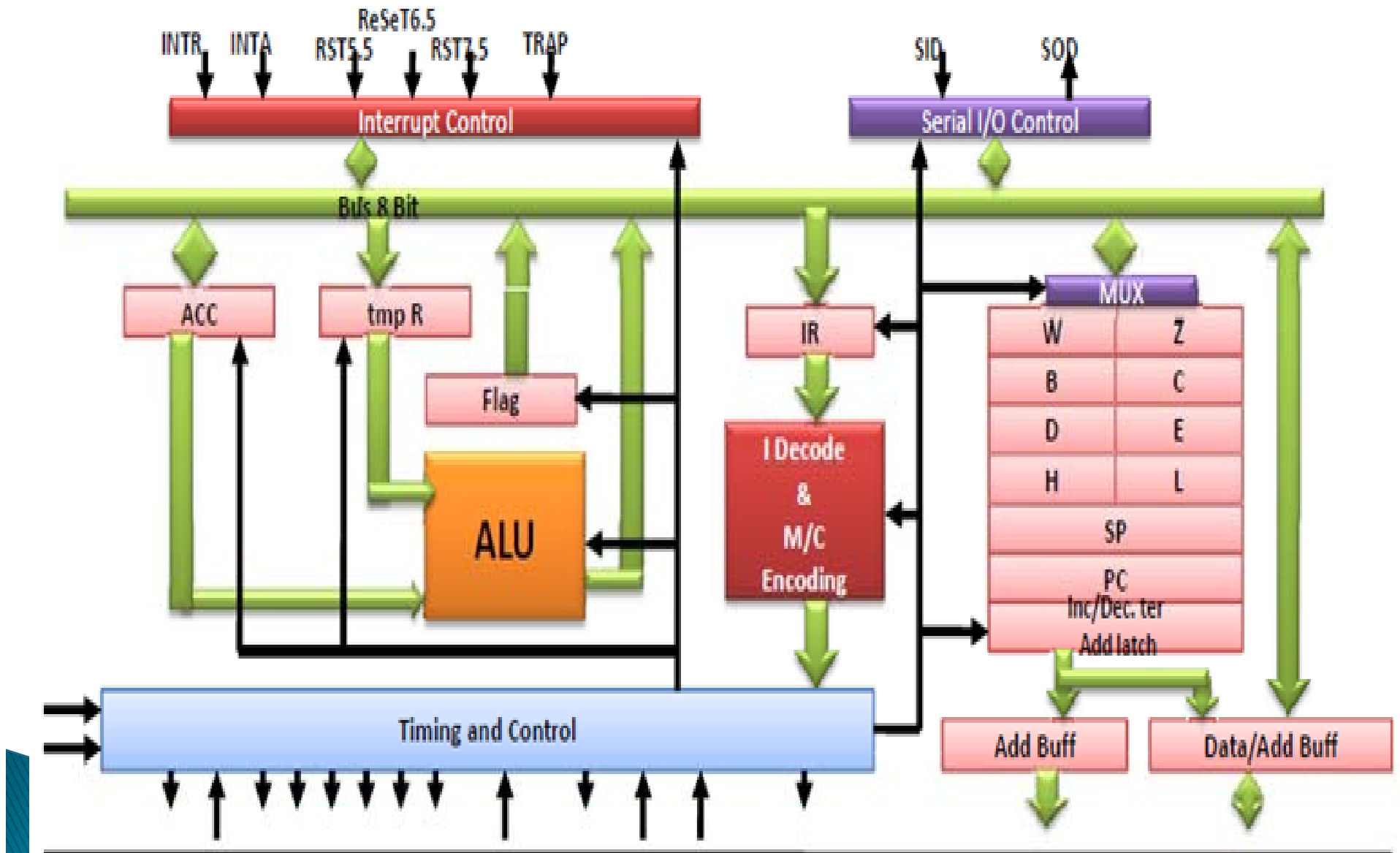

# Feature of 8085 Microprocessor

- ▶ The features of INTEL 8085 are :
  1. It is an 8 bit processor.
  2. It is a single chip N-MOS device with 40 pins.
  3. It has multiplexed address and data bus.(AD0-AD7).
  4. It works on 5 Volt dc power supply.
  5. The maximum clock frequency is 3 MHz while minimum frequency is 500kHz.
  6. It provides 74 instructions with 5 different addressing modes.

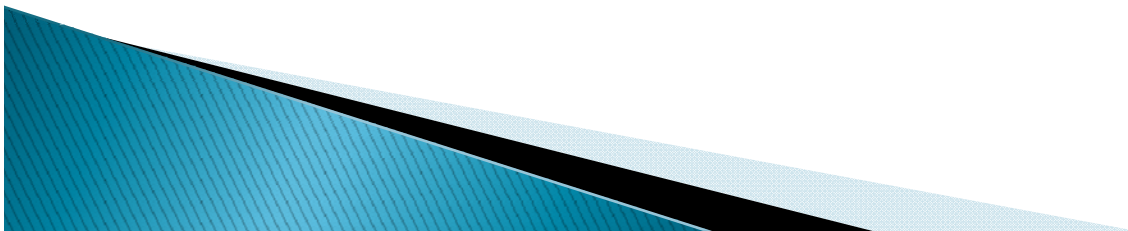

# **POWER SUPPLY & CLOCK FREQUENCY OF 8085:**

- ▶ 8085 require +5V power supply and 3MHz. clock frequency.

- ▶ **FUNCTIONS OF AN ACCUMULATOR:**

- ▶ The accumulator is a register associated with the ALU operations and sometimes I/O operations.
  - ▶ It is an integral part of ALU.
  - ▶ It holds one of data to be processed by ALU. It also temporarily stores the result of the operation performed by the ALU.
- 

## 16 – BIT REGISTERS OF 8085

- I. Stack pointer (SP) and
- II. Program counter (PC).

W(8) Temp. Reg	Z(8) Temp. Reg
B(8) Register	C(8) Register
D(8) Register	E(8) Register
H(8) Register	L(8) Register
Stack Pointer(16)	
Program Counter(16)	



# REGISTER PAIRS OF 8085

- ▶ B-C register pair
- ▶ D-E register pair
- ▶ H-L register pair

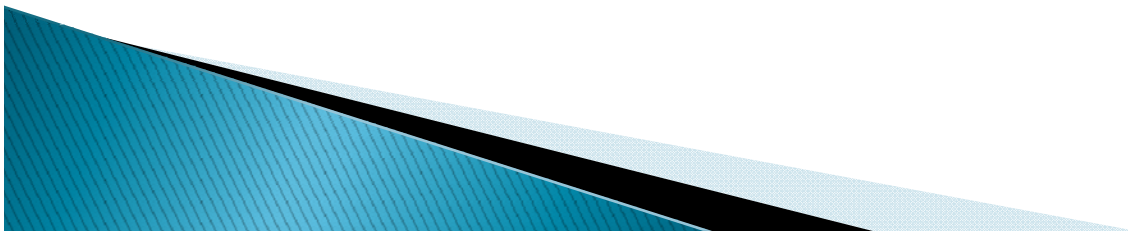

# Registers of 8085 microprocessor

1. Temporary data register
2. Temporary registers W and Z
3. 8-bit accumulator
4. Flag register
5. Six general purpose registers (B, C, D, E, H and L)
6. 16-bit program counter :
7. 16-bit stack pointer -
8. Instruction register.

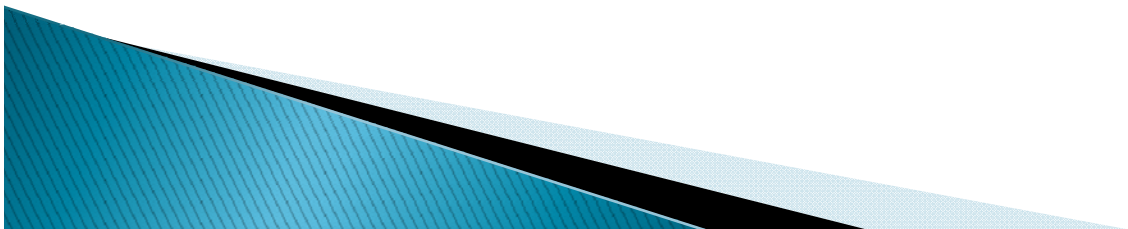

# Registers of 8085

(1) **Temporary Data Register** : This register is also called as operand register. It provides operands to the ALU. It is a 8-bit register and not available to user.

(2) **Temporary Registers (W and Z)** : These registers are used by control section to hold the data during an arithmetic or logical operation. It is hold 8 bit data. These register are **not available to user**. They are internally used by the microprocessor.

**e.g.:**

(a) XCHG (exchange)

(b) XTHL (exchange top of stack with registers H and L).



# Accumulator

**(3) 8-bit accumulator :** This register is used to store the first input as well as result of any calculation is also stored in accumulator. The accumulator is identified as register A. It is an 8-bit general purpose register.

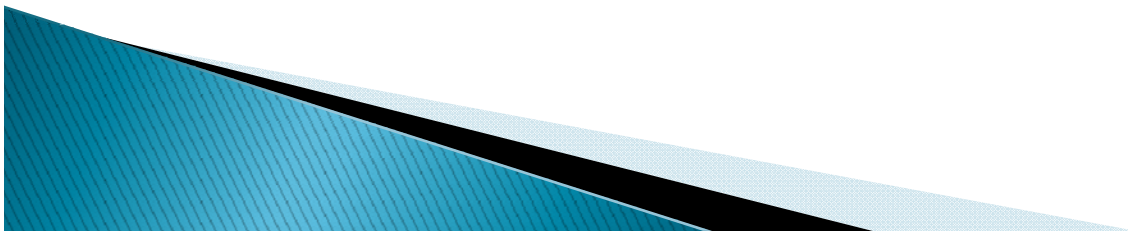

# 4. Flag Register

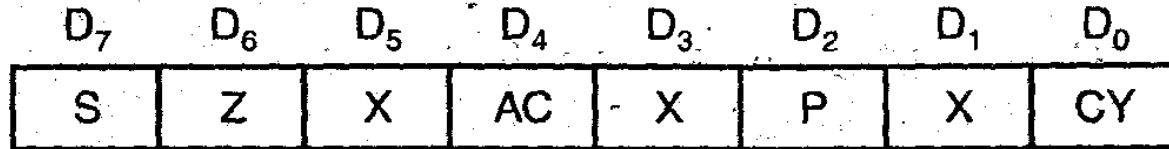

Flag register

- (a) Sign Flag (S)
- (b) Zero Flag (Z)
- (c) Auxiliary Carry Flag (AC)
- (d) Parity Flag (P)
- (e) Carry Flag (CV)

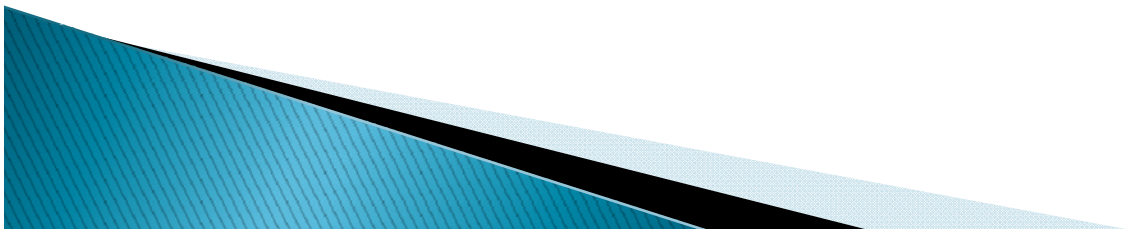

# General purpose register

## (5) Six general purpose registers

**(B, C, D, E, H and L) :** The 8085 microprocessor contains 6 general purpose registers of 8 bits each, named as B, C, D, E, H and L. These registers are programmable by user. They are used to hold data, results of arithmetic and logical operations and address of data memory. The valid register pairs available are BC, DE and HL. The user cannot form a register pair of his/her choice.

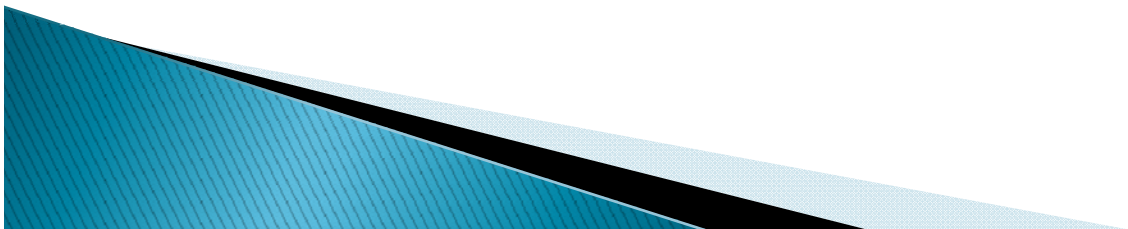

# Pc & SP

**(6) 16-bit program counter (PC) :** The program counter is used to hold the address of program memory. It always points to the next instruction to be fetched i.e. it holds the memory address of the next instruction to be executed.

**(7) 16-bit Stack Pointer (SP):** Stack is a reserved portion of memory where information can be stored to taken back under software control. This memory area is referred to as stack area. The stack pointer is auto decremented by 2 after PUSH operation and auto incremented by 2 after POP operation.



# Instruction Register

**(8) Instruction Register:** An instruction fetched from memory is temporarily stored in Instruction Register before decoding. So after fetching instruction from memory, microprocessor stores it in the instruction register and after this it is decoded.

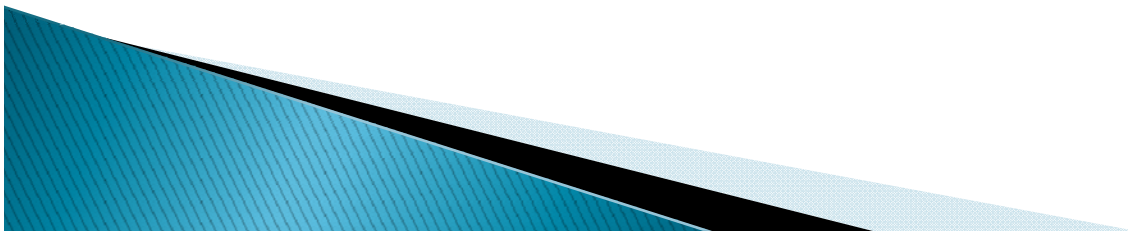



# Register Section :

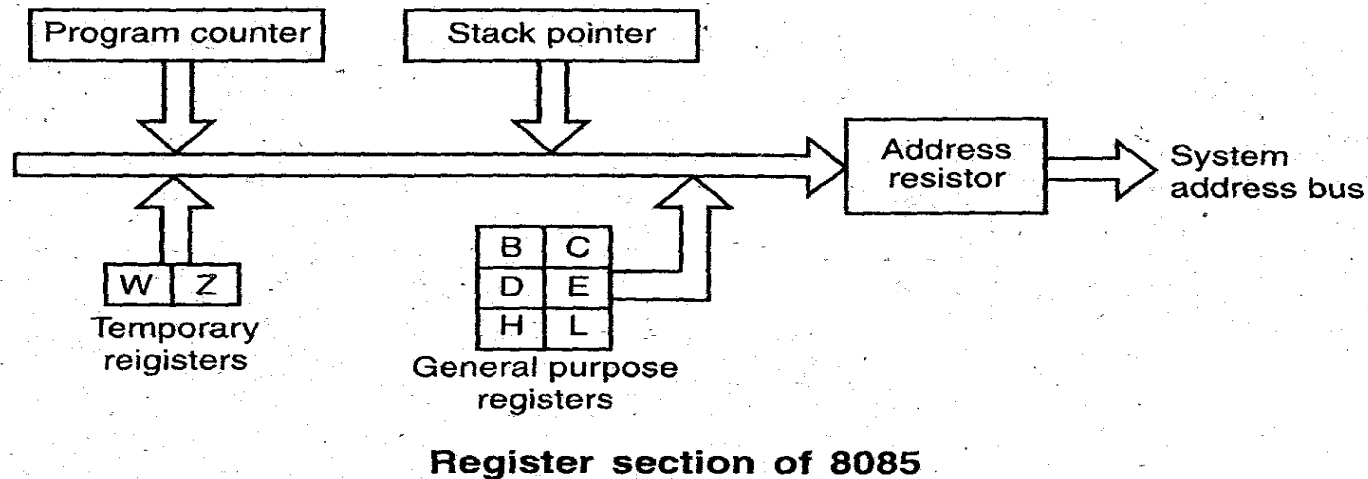

It consists of PIPO (Parallel in parallel out) register. Register contains a set of binary storage cells/flip flops with facilities of read and write. It is used for temporary storage of instructions also used for data and address. Hence, the number of bits in a register is equal to data or address depending on the application. Fig. shows register section of 8085.

# Instruction Register

1. The register is not accessible to user.
2. Instruction register holds the opcode of instruction that is decoded and executed.
3. This opcode is sent for instruction decoder to select one of 256 alternatives.

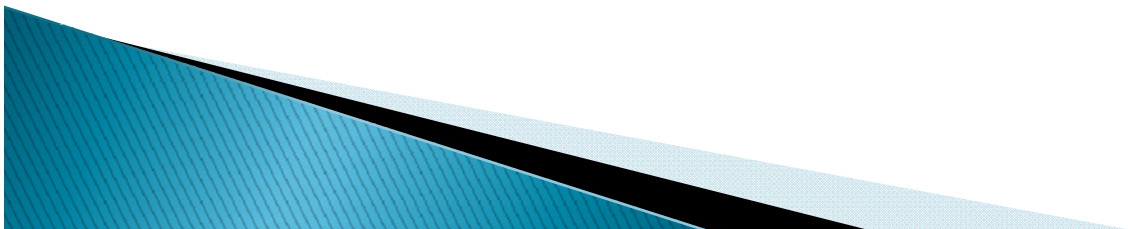

# Program Counter..

1. Used for holding the address of program memory.
2. In reset condition, the program counter is set to 000H, means that the address of first instruction to be fetched and executed.
3. The size of program counter depends upon the number of address bits.

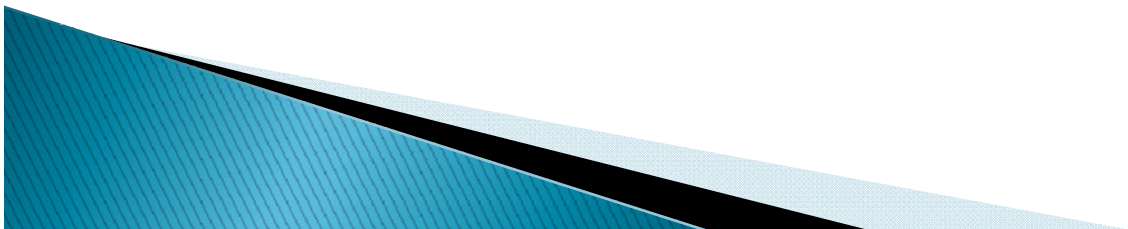

# Program Counter.

4. In case of JUMP and call instructions, the address followed by JUMP and call instructions is placed in program counter. If the condition is satisfied then 8085 fetches the next instruction from the new address specified by JUMP or call instructions.
5. During instruction fetch operation, the contents of program counter on the address bus and it fetches first byte of instruction from memory location.

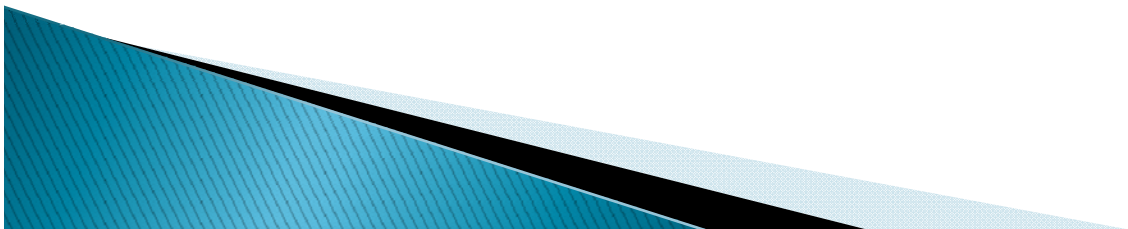

# Stack Pointer

1. It is portion of memory where information can be stored or taken back. This memory area is known as stack area.
2. It is 16-bit register used for defining the stack starting address.
3. Used to keep track of data store don stack.
4. It is loaded with an initial value by means of transfer type instruction.

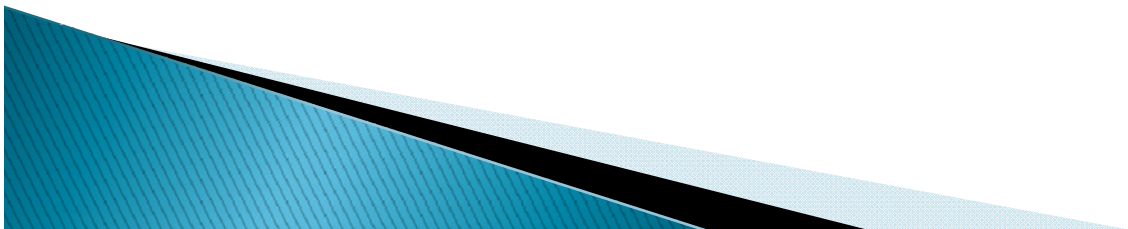

# Arithmetic Logic Unit (ALU)

This section processes all data i.e. it perform arithmetic and logic operations.

1. It performs addition, subtraction and logical, operations like AND, OR, EX-OR.
2. ALU is always controlled by timing and control circuits.
3. It looks after the branching decisions.
4. It provides status of result to the flag register.

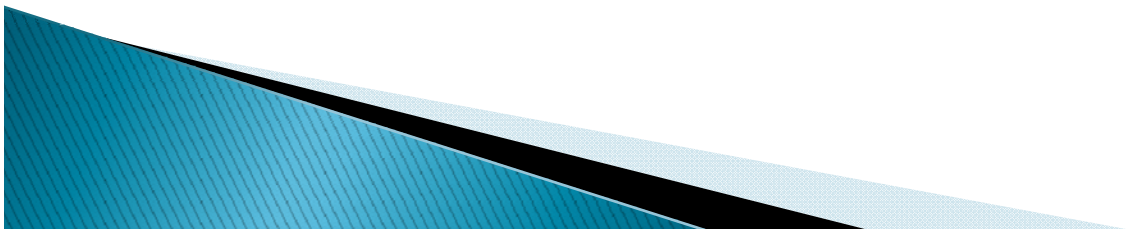

# Scope of research

- ▶ There are lot of research scope in field of microprocessor, today word is electronic world and computer and electronic equipment are using in every field. Improve the quality and feature of the existing microprocessor new research are going on. so there are lot of research scope in this field.

